



www.draminski.com

DRAMINSKI ED2

Electronic estrous detector
for cows, mares, sheeps, goats, sows



MANUAL

EN

ISO 9001 | CE

TABLE OF CONTENTS

		INTRODUCTION	3
SECTION	1	ACCESSORIES	5
SECTION	2	DESIGN OF THE DEVICE	9
SECTION	3	KEYBOARD FUNCTIONS	15
SECTION	4	STARTUP OF THE INSTRUMENT.	17
SECTION	5	NOTES TO THE MEASUREMENTS	21
SECTION	6	EXAMINATION OF ANIMALS	25
SECTION	7	METHOD OF INSERTING THE PROBE	29
SECTION	8	DISINFECTION	31
SECTION	9	INTERPRETATION OF THE RESULTS	35
SECTION	10	MAIN MENU	39
SECTION	11	BATTERY REPLACEMENT	49
SECTION	12	FINAL REMARKS.	51
SECTION	13	TECHNICAL DATA	53

INTRODUCTION

One of the basic elements in the organization of animal breeding is the detection of the moment of ovulation. It is of key importance for the effectiveness of female mating (effective mating at the right moment depends to a large extent on this). Searching for a reliable and simple method of ovulation detection, scientists and animal breeders have identified a direct correlation between changes in the electrical resistance of the vaginal mucus and the occurrence of ovulation.

In the course of research on the properties of vaginal mucus, scientists found that the closer to ovulation, the greater the change in electrical resistance. Current knowledge of animal physiology, especially regarding changes in the genital organs during the oestrous cycle, enabled the science to understand the correlation between changes in the ovaries and changes in the electrical resistance of the mucous membrane in the animal's vagina. All the above-mentioned phenomena and the dependence of electrical resistance on ovulation were used in the construction of DRAMIŃSKI ED2 (Estrous Detector).

The manufacturer – DRAMIŃSKI S.A. serves the users with its knowledge and at the same time reserves the right to introduce changes and improvements in design and software. DRAMIŃSKI

S.A. also reserves the right to amend the contents of the manual. Read this manual carefully before starting the device. This will guarantee safe, long and reliable operation of the instrument.

The amount of electric current flowing through the measuring electrodes and the electric field produced by this mini-current is completely harmless to animals and humans.

The declaration of conformity of the device is available at the seat of DRAMIŃSKI S.A., ul. Owocowa 17, 10-860 Olsztyn, Poland.

For more information and always up-to-date data please visit www.draminski.com



Please note that electronic equipment, batteries and accumulators must not be disposed of in standard household waste containers. It is the user's responsibility to dispose of this type of waste to appropriate disposal companies in accordance with the applicable laws and regulations. By ensuring proper disposal, you help to protect the environment.

ACCESSORIES

SECTION 1

EN

Electronic estrous detector for cows and mares Dramiński EDC2

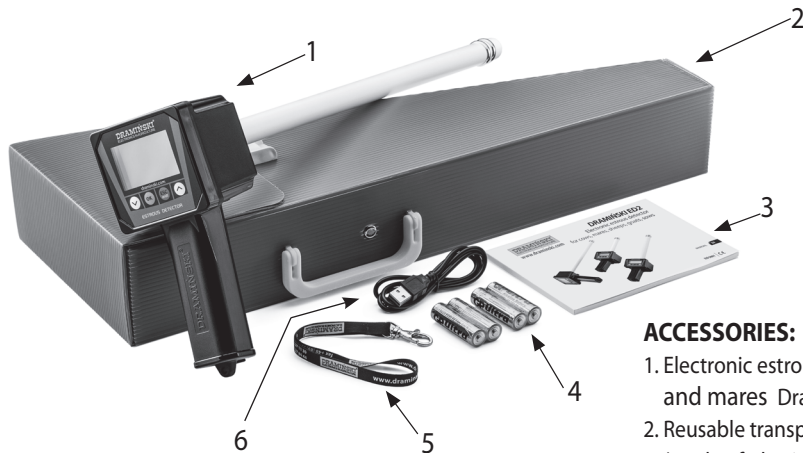

ACCESSORIES:

1. Electronic estrous detector for cows and mares Dramiński EDC2.
2. Reusable transport packaging (made of plastic).
3. Operation manual.
4. 4 1.5V batteries type AA, LR6.
5. Leash with a metal snap hook.
6. USB-miniUSB cable for communication with a computer.

Electronic estrous detector for sheep and goats Dрамиński EDS2

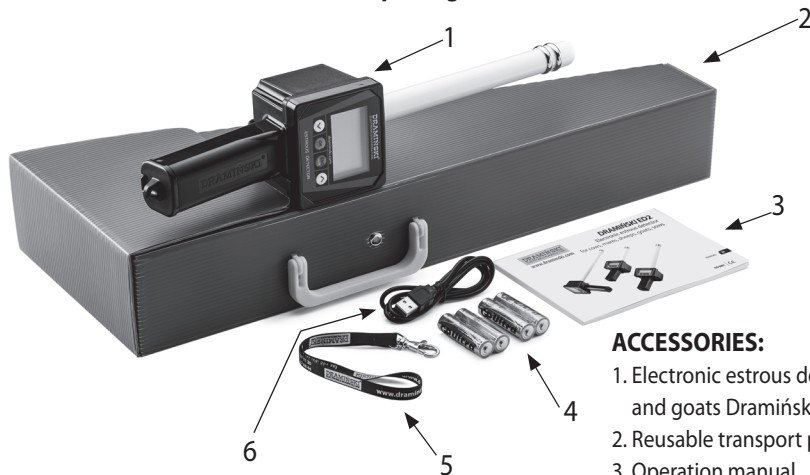

ACCESSORIES:

1. Electronic estrous detector for sheep and goats Dрамиński EDS2.
2. Reusable transport packaging (made of plastic).
3. Operation manual.
4. 4 1.5V batteries type AA, LR6.
5. Leash with a metal snap hook.
6. USB-miniUSB cable for communication with a computer.

Electronic estrous detector for sows Dрамиński EDP2

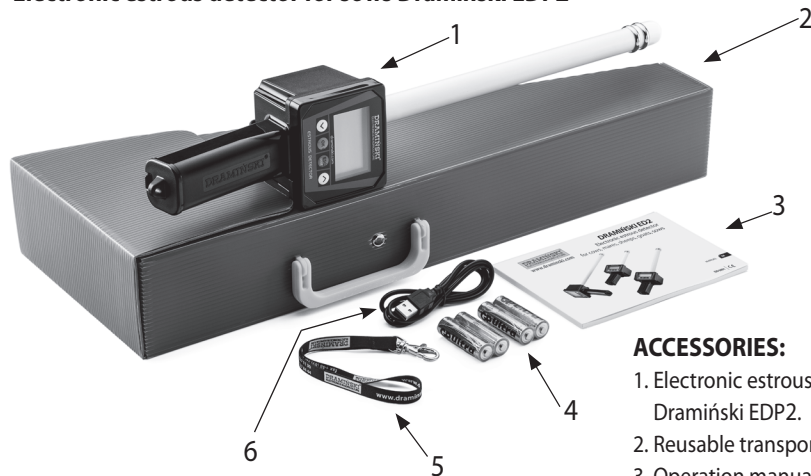

ACCESSORIES:

1. Electronic estrous detector for sows Dрамиński EDP2.
2. Reusable transport packaging (made of plastic).
3. Operation manual.
4. 4 1.5V batteries type AA, LR6.
5. Leash with a metal snap hook.
6. USB-miniUSB cable for communication with a computer.

DESIGN OF THE DEVICE

SECTION **2**

EN

EXTERNAL DESIGN EDC2

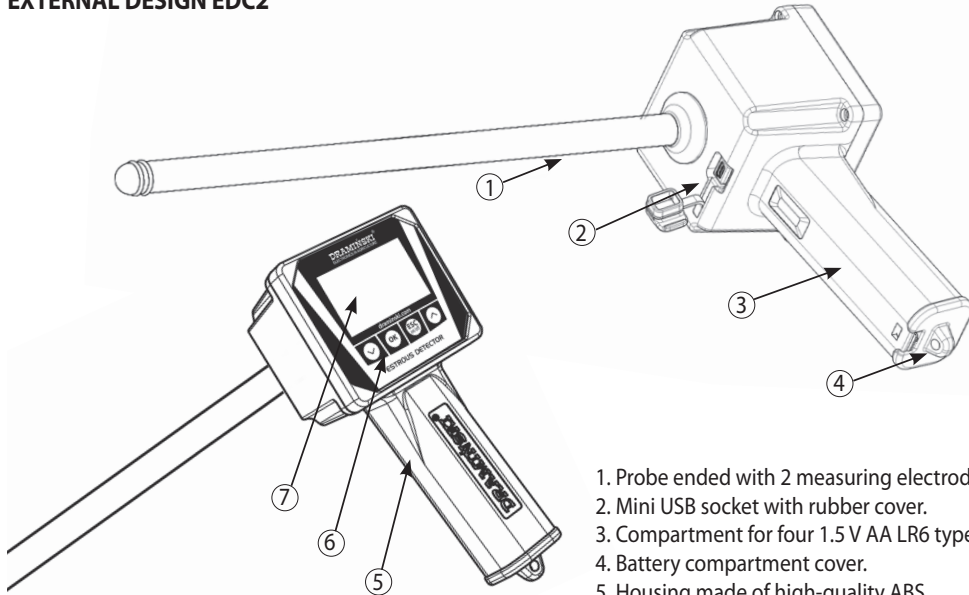

1. Probe ended with 2 measuring electrodes.
2. Mini USB socket with rubber cover.
3. Compartment for four 1.5 V AA LR6 type batteries.
4. Battery compartment cover.
5. Housing made of high-quality ABS.
6. Membrane keyboard.
7. Graphic LCD display with LED backlighting.

APPROXIMATE DIMENSIONS EDC2

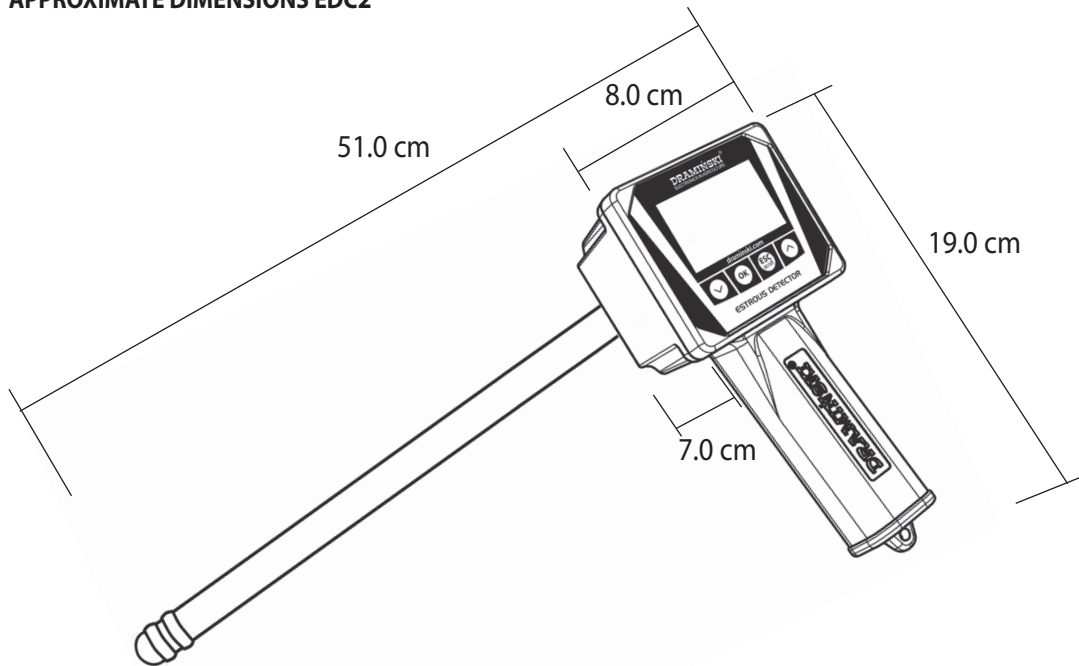

APPROXIMATE DIMENSIONS EDP2

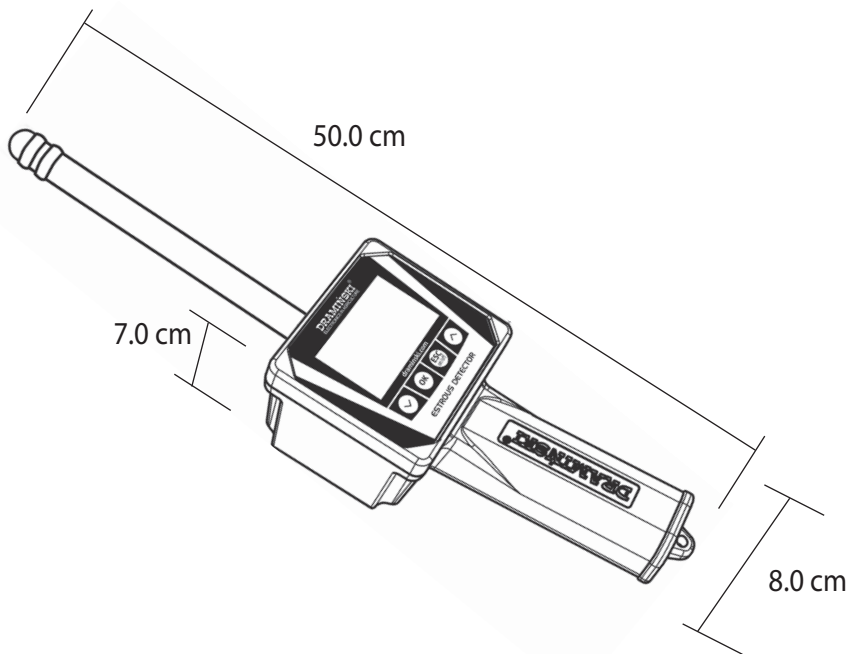





KEYBOARD FUNCTIONS

SECTION **3**

EN



	<ul style="list-style-type: none"> - Turning on the device. - Turning off the device by holding down the key for 5 seconds (NOTE! The ovulation detector can also be turned off via the menu by using the "Turn off!" option, and if not in use, it will automatically turn off to save batteries). - Turning on the main menu by holding down the key for 2 seconds. - Cancelling program functions.
	<ul style="list-style-type: none"> - Accepting program functions. - Start of the measurement.
	<ul style="list-style-type: none"> - Navigation through the menu. - Setting values in menu options.
	<ul style="list-style-type: none"> - Turning on the list of animals stored in the device's memory.
	<ul style="list-style-type: none"> - Saving the result with date and time to the device's memory.

STARTUP OF THE INSTRUMENT

SECTION 4

EN

Dramiński ED2 will be ready for use if the container includes properly inserted batteries (note polarity).

Switch on the device with the  button.

a) A welcome message will appear on the display indicating the name of the device, the software version and the serial number.



b) The device shall then enter the measuring mode. A model of the device (EDC2 for examining cows and mares / EDS2 for examining sheep and goats / EDP2 for examining sows) and the current battery status will appear in the upper part of the display. 3 digits, of which 1 will flash informing that the device waits for 1 of 3 measurements will appear in the middle of the display. Then, the result will appear (it is possible to modify the number of readings in the measurement cycle in the menu). There are currently available menu functions over specific keyboard keys (e.g. if you click on the button 

in a given moment, the menu will start) in the lower part of the display.

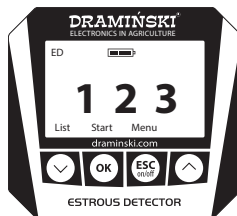

If you activate **advanced** mode in the menu of the device, the display also shows the possibility of saving the current date and time and the name of the animal, (or e.g. the number of the earring) for which the results will be catalogued, in the memory.

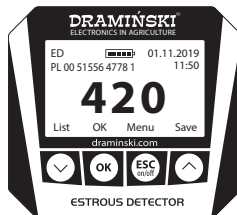

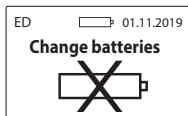

Note! If the batteries are too weak to continue the work, the device will automatically signal this with a message:

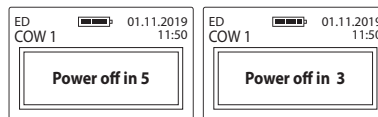

which means the need to replace the batteries with a new ones.

- c) To save battery life when the keys are not in use, the device will pass into standby mode after a period of time, i.e. the backlight will turn off (this time can be changed in the menu). Press any key to return to the operating state.
- d) If the estrous detector remains in standby mode for several minutes, the device will automatically shut down (this time can be set in the menu). The display will show a countdown from 10 to 0 which can be interrupted by any key, but if you do not do so, the device will turn itself off in order to save power.



- e) To turn off the device by yourself, hold down the  button for 5 seconds or select the option **“Turn off!”** in the main menu.

NOTE! Advanced mode users can download from our website www.draminski.com a special program for communication with a computer, which allows you to download data from the device to the computer hard drive to conveniently and accurately analyse results, archive data, save valuable notes, create special reports, printouts, generate estrous waveforms from the results stored in the memory of the device, etc.

NOTES TO THE MEASUREMENTS

SECTION **5**

EN

– The housing of the detector is made of the top-quality ABS material resistant to shocks, atmospheric factors and most chemical substances. The device is moisture-resistant, which makes it easier to keep it in a clean and hygienic condition.

– Dрамиński ED2 is factory set for a measurement cycle consisting of 3 measurements, successively accepted with the **OK** key, thanks to which the device will display the result indicating the measured number of units after the third measurement. However, in the case of very restless animals it is more convenient when the measurement cycle consists of 1 measurement to make the examination last shorter. Therefore, the number of measurements in the measurement cycle can be changed from the menu according to the user's needs (see section: MAIN MENU).

– The measuring range is set to suit all breeds and is in the range from 0 to 2,000 units. When the measuring range is exceeded, e.g. when the test is performed "in the air" with the electrodes not covered with mucus, 3 horizon-

tal dashes (- -) will appear on the display.

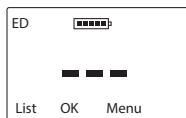

– Before use, make sure that the electrodes are clean (degreased). Contaminations after the measurement or residual urine on the probe may have an adverse effect on the measurement results. It is forbidden to use any type of lubricants because they will hinder vaginal mucus contact with the electrodes.

– Before using Dрамиński ED2 for the first time, the user should:

a) take several measurements on a certain number of females which certainly have an oestrous cycle.

b) take several measurements on a few females which clearly do not have an oestrous cycle.

Observing the differences in readings between stages 1 and 2 will help the beginner to become familiar with the functioning of the device and understand the differences between particular animals.

– The functioning of the detector can also be checked as follows:

a) place the tip of the probe in a container with clean water and perform a measurement cycle. The result will be either very high or exceeding the range (“- - -” message) because water resistance is generally quite high. In practice this does not happen because the electrical resistance of the vaginal mucus is much lower than the maximum detection range of the device.

b) add a pinch of salt to the water and mix thoroughly. Immerse the tip of the probe and perform a measurement cycle. Now the result should be much lower as salt lowers the electrical resistance of the solution (lower resistance = lower reading).

c) adding another pinch of salt will further reduce the reading (during measurements, the probe should be in a similar position inside the vessel).

This simple experience illustrates the function of the detector and the phenomenon of an abnormal drop of reading due to urine on the electrodes, as urine also contains salt.

EXAMINATION OF ANIMALS

SECTION 6

EN

Before starting the examination, proceed with the following steps:

- a) switch on the device and check the display for sufficient battery charge,
- b) prepare a disinfectant to sterilize the probe (see chapter: DISINFECTION),
- c) if the vulva area is dirty, wash and wipe it,
- d) in order to use the possibility of saving the results in the memory, activate the advanced operating mode in the menu of the device, make sure that the date and time are set correctly, select the animal to be examined from the list (or add a new one in the menu, see chapter: SETTINGS).

Examination:

- a) switch on the device,
- b) open the animal's vulva and begin the gentle insertion of the vaginal probe (see chapter: METHOD OF INSERTING THE PROBE),
- c) Before taking the measurement, make a circular motion within the axis of the device in order to obtain the best possible contact between the electrodes and the mucus. The measurement should be taken at the lower edge of the cervical outlet.

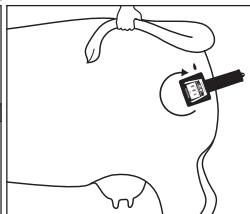
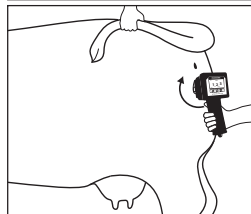
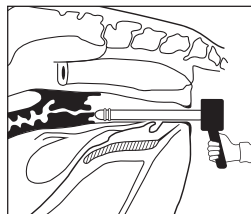

If the device is in the measurement mode, the display shows a flashing one "1" which means that the device is waiting for the first measurement,

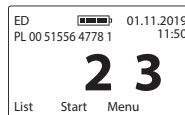

so when the probe is correctly positioned in the animal's vagina, click the **OK** button to take a measurement (during this time the display shows "Wait!")

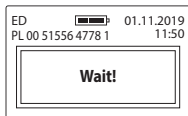

when the message "Wait!" is displayed, (approx. 1 second) hold the device still as the measurement is made during this time,

- f) similarly, before second and third measurements, a circular motion should be made in the axis of the device to improve the contact of the mucus with the probe electrodes and confirm with the **OK** button,
- g) at the end of the measurement cycle, i.e. when the third measurement is validated, the display shows the result in terms of the number of units measured, e.g.

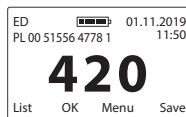

- h) after completion of the examination, the probe must be removed from the animal's vagina,
- i) switch off the device,
- j) disinfect the instrument (see chapter: DISINFECTION).

CAUTION

It is necessary to rotate the probe inside the animal by 360° before each measurement during the measurement cycle to ensure the best possible (100%) contact between the measuring electrodes and the vaginal mucus. In this way, you can always obtain accurate and correct results.

METHOD OF INSERTING THE PROBE

SECTION **7**

EN

In order to facilitate the examination/measurement, a second person may participate in this activity if necessary. Open the animal's vulva and begin the gentle insertion of the decontaminated probe into the vagina (do not use lubricants).

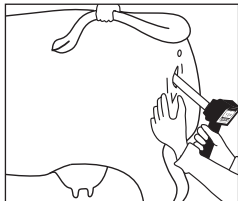

It is best to introduce the probe initially from the bottom upwards at an angle of approximately 45 degrees to avoid inserting the probe into the urethra.

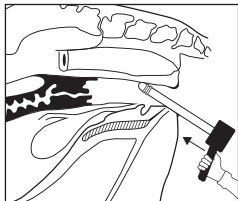

Then introduce horizontally until resistance is felt, so that the tip of the probe, on which both electrodes are placed, reaches the end of the animal's vagina, i.e. the cervical outlet, and then rotate around the axis of the probe in order to obtain the best possible contact between the electrodes and the mucus (rotate before each reading in the measurement cycle).

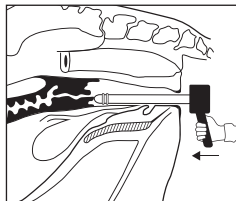

Measurement should always be made at the lower edge of the cervical outlet in the same way.

NOTE! The depth of the probe insertion depends on the anatomical structure and may vary from animal to animal, so it is always important to ensure that the probe is inserted until resistance is felt.

DISINFECTION

SECTION 8

EN

Accurate and thorough cleaning and disinfection of the device is one of the most important conditions for proper use of the ESTROUS DETECTOR.

- It is mandatory to disinfect the ESTROUS DETECTOR before and after each measurement.
- In addition, it is advisable to wipe the probe carefully with a paper towel so that no dirt, faeces, mucus or hair remains on the probe, particularly at the edges of the electrodes. In order to properly disinfect the device probe, it is best to wash it thoroughly with water. Then immerse the probe in the disinfectant solution container.

NOTE! Do not use very hot water or boiling water during washing.

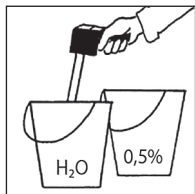

- To disinfect, use a solution of disinfectant prepared in a container (e.g. a plastic bucket). The first container is used for washing and the second for disinfecting the instrument.
- The concentration of the disinfectant should be chosen according to the recommendations of the manufacturer of the preparation. Solutions with a concentration of 0.5–1% are most often recommended. The disinfection time should be at least several dozen seconds to ensure the effectiveness of the disinfectant.

NOTE! The disinfectant and its solution may irritate the vaginal mucosa, so the recommended concentration should be observed.

When more measurements are taken, the disinfectant solution gradually reduces its effectiveness, so it is necessary to prepare the solution anew, immediately before further examination.

DRAMÍŃSKI S.A. wishes to emphasize the importance of keeping the detector clean. Lack of care in this respect may lead to infection of the reproductive tract. After each use, wash the detector, disinfect and dry it.

INTERPRETATION OF RESULTS

SECTION 9

EN

Figure 1 shows a diagram of changes in vaginal mucus resistance in the vagina during the estrous cycle and indicates the moment of estrous occurrence.

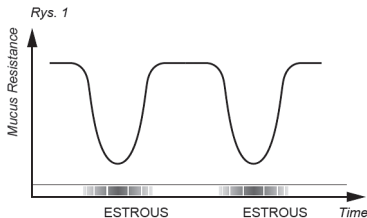

If the animal is outside the estrous period, a high level of resistance is observed (depending on the female species, e.g. in cows it will be about 300 units or more). As the peak phase of the estrous approaches, the resistance drops to a minimum value (e.g. 200 units for cows), then rises again to a high level and remains as such until the next estrous occurs. In practice, when taking measurements, it is necessary to capture the minimum and then the moment of significant increase in the results, therefore during the estrous period the measurements should be taken at the appropriate frequency (up to several times a day).

Too few measurements (e.g. every few days) will cause the wrong interpretation of the results and the omission of an important moment of estrous – the time of ovulation.

Figure 2 shows the resistance diagram for effective mating or insemination. The value of resistance after the end of estrous during pregnancy remains at a high level until the date of birth.

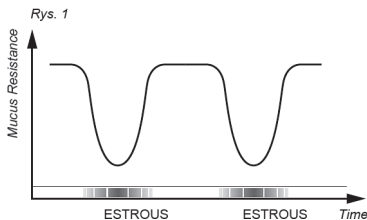

Estrous detection

Examples of mucus resistance changes in different species are shown in the following graphs. Remember that estrous detection involves capturing a minimum of indications and then the moment of a clear increase in the results. This increase means that ovulation is approaching, which should take place within from a few to a dozen of hours. This is the best time to inseminate or mate. The course of resistance variation shall be observed during the examination of animals. The period of heat does not last long, so during this period, measurements should be taken more

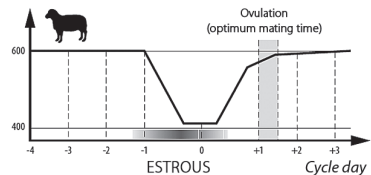
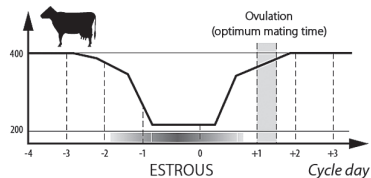
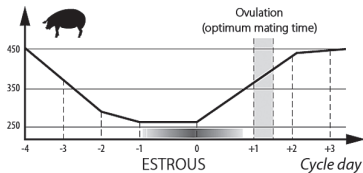
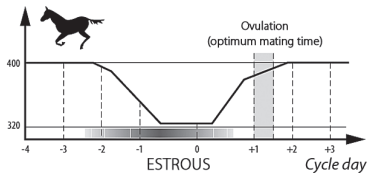

Remember! The values of mucus resistance in time of estrous and outside the period of estrous shown in the drawings are indicative readings. It should be emphasized that in practice there is a high individual variability.

MAIN MENU

SECTION **10**





EN

Thanks to the functions contained in the main menu of the device, the user can quickly turn off the device, adjust operational settings to their needs, manage memory and much more.

To turn on the MAIN MENU, press and hold down the

 **key for about 2 seconds.**

1. Turn off!

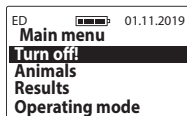

To turn off the device, go to the **Main menu** using the  key, then use the  or  key to select the **Turn off!** option and confirm with the  key.





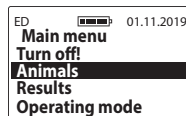

Thanks to this function, the user can quickly and conveniently turn off the device without the necessity to hold down the  key for 5 seconds and wait for the power auto off option to activate.

2. Animals

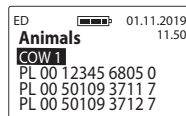

a) **Change animal** – to change the animal for which the results will be put into the directory, go to the **Main menu / Animals / Change animal**, then use the  or  key to select the appropriate bitch from the list and confirm with the  key, e.g.



b) **New animal** – to add a new bitch to the device's memory, go to the **Main menu / Animals / New animal**, then enter any name by selecting characters using the arrows and confirming with the  key (to clear the character select the "<" symbol and press the  key). When the name is entered, press the  key and when the **Save**

the name?” message appears, confirm with the **OK** key or cancel with the **ESC** key, e.g.

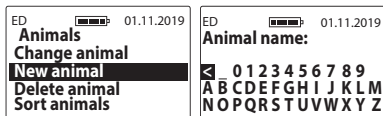

c) **Delete animal** – to delete an animal from the device’s memory, together with the measurements stored for it, go to the **Main menu / Animals / Delete animal**, then select the appropriate animal from the list and confirm with the **OK** key or cancel with the **ESC** key (Note! the animal and its measurements will be irreversibly deleted from the device, therefore if the data is important, remember to first transfer it to the computer using special software), e.g.

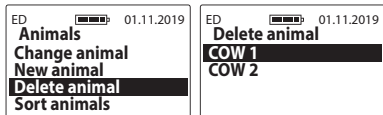

d) **Sort animals** – to sort previously saved animals, go to **Main menu / Animals / Sort animals** and confirm with the **OK** button. The animals included in the list are shown in the order of their entry and will be sorted alphabetically. This option is very useful when searching for a specific animal included in the list of animals (especially when the animals are named according to the numbering of ear tags).





3. Results

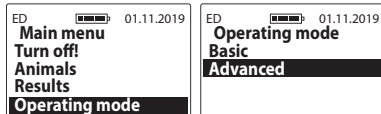
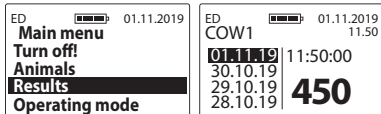

To view the results stored in the device’s memory, go to the **Main menu / Results** and then scroll through them using the **↓** or **↑** key (the results are arranged chronologically starting with the newest ones). You can also delete individual results. To do this, use the arrows to indicate the result you would like to delete and use the **OK** key, and when the **“Delete?”** message appears, confirm with the **OK** key or cancel with the **ESC** key, e.g.

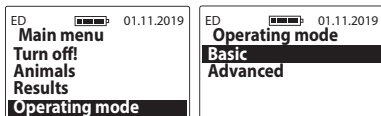

4. Operating mode

- a) **Basic** – in order to facilitate the operation of the device and use only the basic menu functions, go to the **Main menu / Operating mode**, then using the  or  key select the **Basic** option and confirm with the  key, e.g.





- b) **Advanced** – in order to enable all the options of the device such as real time clock, saving measurements, etc. go to the **Main menu / Operating mode**, then using the  or  key select the **Advanced** option and confirm with the  key, e.g.

5. Settings



5.1 Language

To change the language version of the device, go to the **Main menu / Settings / Language**, then select the language version using the  or  key and confirm with the  key, e.g.

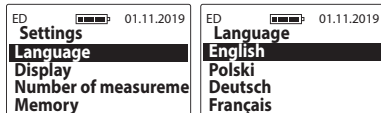

5.2 Display

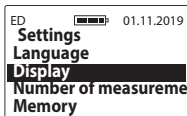

- 5.2 a) **Backlight intensity** – we used energy-saving LED backlighting but remember that stronger backlighting is associated with increased power consumption, which leads to a faster discharge of the battery. To change the backlight intensity, go to the **Main menu / Settings / Display / Backlight intensity**, then select the appropriate value using the \downarrow or \uparrow key and confirm with the OK key, e.g.

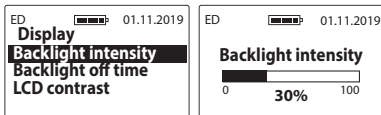

- 5.2 b) **Backlight off time** – adjustment of the time after which the backlight of the display is off and the device goes into the idle state waiting for the keyboard

to be used again (the time is counted from the last click/use of the key on the keyboard of the device). To change the backlight off time, go to the **Main menu / Settings / Display / Backlight off time**, then select the appropriate value using the \downarrow or \uparrow key and confirm with the OK key, e.g.

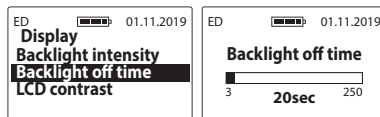

- 5.2 c) **LCD contrast** – to change the contrast of the display, go to the **Main menu / Settings / Display / LCD contrast**, then select the appropriate value using the \downarrow or \uparrow key and confirm with the OK key, e.g.

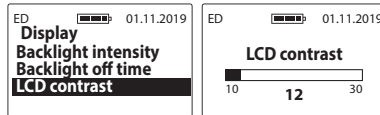

5.3 Number of measurements

We recommend that the measurement cycle consists of

3 readings, while in the case of very restless bitches that are difficult to hold during the test, it is possible to set 1 reading in the instrument menu, which significantly shortens the time of the entire test. To change the number of readings in the measurement cycle, go to the **Main menu / Settings / Number of measurements**, then use the \downarrow or \uparrow key to select the appropriate number and confirm with the OK key, e.g.

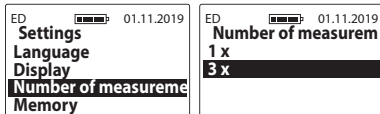

5.4 Memory

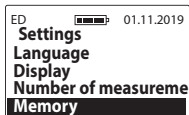

5.4 a) **Available memory** – to check the current amount of free space in the device's memory, go to the **Main menu / Settings / Memory**, use the \downarrow or \uparrow key

to select the **Available memory** option and confirm with the OK key, e.g.

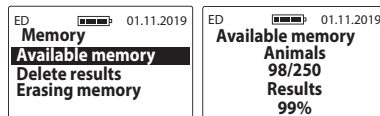

5.4 b) **Delete results** – to delete all results stored in the device's memory, go to the **Main menu / Settings / Delete results**, and confirm with the OK key. This option deletes the results from all animals stored in the device (the animals will not be deleted). **Note!** Examination results will be irretrievably deleted from the device, so if the data is important, remember to first transfer it to the computer using special software.

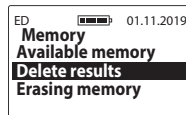

5.4 c) **Erasing memory** – to erase the entire device memory (all results and animals), enter the **Main menu / Settings / Memory / Erasing memory** and confirm with **OK**. **Warning!** The data will be irretrievably erased from the device, so if it is relevant, remember to first transfer it to your computer using special software.



5.5 Power auto off

Adjustment of the time after which the device turns off automatically counting from the last click/use of the keyboard. To change the power automatic off time, go to the **Main menu / Settings / Power auto off**, then select the appropriate value using the **↓** or **↑** key and confirm with the **OK** key, e.g.

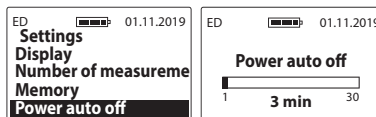

5.6 Date & time

ED2 has a real time clock so that the measurement results are stored in the memory together with the actual date and time of performance.

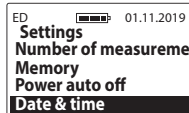

5.6 a) **Set date** – to set the current date, go to the **Main menu / Settings / Date & time / Set date**, then use the **↓** or **↑** key to select the appropriate value and press the **OK** key to confirm the year/month/day, e.g.

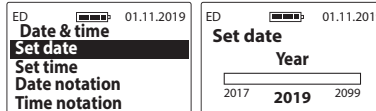

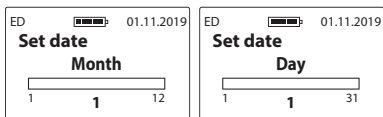

5.6 b) **Set time** – to set the current time, go to the **Main menu / Settings / Date & time / Set time**, then use the \downarrow or \uparrow key to select the appropriate value and press the OK key to confirm the hour/minutes, e.g.

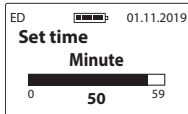
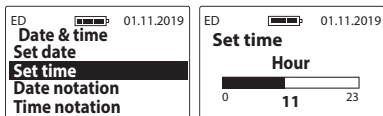



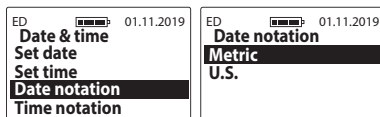

5.6 c) **Date notation** – to change the format of date display, go to the **Main menu / Settings / Date & time / Date notation**, then use the \downarrow or \uparrow key to select the appropriate option and confirm with the OK key, e.g.

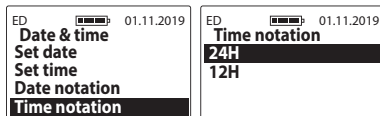

5.6 d) **Time notation** – to change the format of date display, go to the **Main menu / Settings / Date & time / Time notation**, then use the \downarrow or \uparrow key to select the appropriate option and confirm with the OK key, e.g.



6. About

To check the device information and manufacturer's contact details, go to the **Main menu** using the  key, then use the  or  key to select the **About** option and confirm with the  key.

Here we can conveniently check e.g. model of the device, software version, serial number of the device as well as the address and contact details of Dramiński S.A. on page 2 e.g.



BATTERY REPLACEMENT

SECTION 11

EN

The device features an automatic indication that the battery is discharged. In this case, the **“Change batteries”** message in the form of a graphic symbol will be displayed immediately after turning on or during use and the device will automatically turn off.

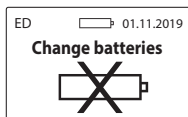

The device is powered by four standard 1.5 V AA type batteries (commonly known as Mignons).

To replace the batteries, it is necessary to:

- Press the lock lever of the battery compartment cover,
- Remove the cover from the battery compartment,
- Remove used batteries and insert a new battery pack according to the polarity markings + / -,
- Press the battery compartment cover until you hear a clearly audible click,

- Check whether the cover has latched properly into the container to make sure that it does not slip out.

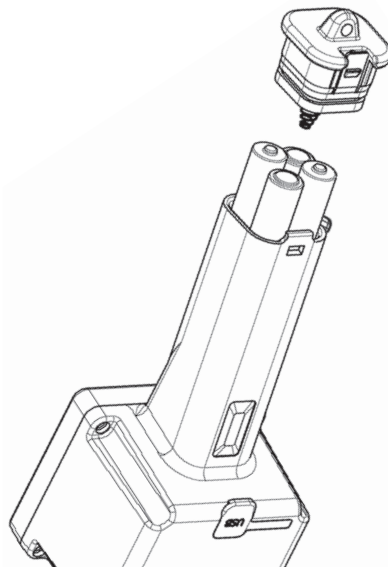

FINAL REMARKS

SECTION 12

EN

- We advise you not to lend the device to other breeders in order to reduce the risk of transmission of infectious diseases.
- Strictly observe the disinfection procedures.
- Store the device in dry conditions at room temperature.
- Wash the instrument in lukewarm water - do not use hot or boiling water.
- Dirt or grease from the skin on the electrodes causes false (overstated) readings, while urine on the electrodes or solutions containing salt cause decreased readings.
- Measurements should always be taken in the same way and in the same vaginal position, which guarantees absolutely reliable results.
- If the device is not going to be used for a longer period of time, we recommend that you remove the batteries from the battery compartment of the device to reduce the risk of damage resulting from electrolyte leakage.

We recommend using good quality batteries.

- In case of problems with the device or difficulties in interpreting the results, we recommend (before sending the device for service) contacting the manufacturer, i.e. DRAMIŃSKI S.A. or a local authorized and certified distributor.
- DRAMIŃSKI S.A. requests all breeders to send their comments and inform us about the results of using the device.
- It is not allowed to use lubricants for the test because they limit the contact of the electrodes with the mucus, which may bias the results.
- It is forbidden to unscrew the display window, interfere with it or have it serviced by unauthorized persons, as this may cause unsealing of the device, permanent damage and will affect the warranty conditions.

TECHNICAL DATA

SECTION **13**

EN

Approximate unit weight EDS2 / EDP2 / EDC2	450 g / 520 g / 540 g
Approximate dimensions EDS2 / EDP2 / EDC2	40 x 8 x 7 cm / 50 x 8 x 7 cm / 51 x 8 x 19 cm
Probe length EDS2 / EDP2 / EDC2	20 cm / 30 cm / 43 cm
Power supply	four 1.5 V AA type batteries (LR6)
Battery status indication	graphic
Battery low indication	automatic
Power consumption	from 11 mA to 54 mA (depending on the set backlight intensity)
Measurement control	single chip microcomputer
Estimated continuous working time on one alkaline battery pack	209 hours when backlight is set to 0% 95 hours when backlight is set to 30%
Display	LCD display with LED backlighting, diagonal 2.4'
Keyboard	membrane
Data transmission	via USB
Update	via USB
Data recording	internal memory
Memory capacity	250 animals / 200,000 measurements with date and time
Measurement range	0-2,000 units
Additional functions	real time clock, LED backlighting, pop-up menu, saving the results, software for data transmission and analysis (reports, graphs, printouts, archiving), independent software update
Measurement resolution	10 units
Recommended working temperature	from 10°C to 45°C
Recommended storage temperature	from 5°C to 50°C

www.draminski.com



DRAMIŃSKI S.A.

Owocowa 17, 10-860 Olsztyn, Poland

tel. +48 89 527 11 30

e-mail: dm@draminski.com

Instr.ED21119EN1.0